

RACE

TRACK NAME

CITY / COUNTRY

DATE

TEMPERATURE AIR TRACK

QUALIFYING POSITION BEST LAP TIME FINAL POSITION RACE LENGTH

SEC MIN

TRACK CONDITION CARPET ASPHALT

TECHNICAL MIXED FAST

TRACTION LOW MEDIUM HIGH

TRANSMISSION

GEAR DIFF CST Number of Gears

SPOOL 2 4

PINION T SPUR GEAR T

FINAL DRIVE RATIO FDR 2.11

SHOCK PDS CYLINDER

FRONT+PDS REAR+PDS

FRONT OIL REAR

CST OIL CST

SPRING

HOLES / DIAMETER

% REBOUND %

ANTI-ROLL BAR

FRONT mm REAR mm

TIRES

ADDITIVE TIMING

ADDITIVE

FL FR RL RR TREATED AREA

FL FR RL RR TREATED AREA

FL FR RL RR TREATED AREA

FL FR RL RR TREATED AREA

FL FR RL RR TREATED AREA

FL FR RL RR TREATED AREA

FL FR RL RR TREATED AREA

FL FR RL RR TREATED AREA

FL FR RL RR TREATED AREA

FL FR RL RR TREATED AREA

FL FR RL RR TREATED AREA

FL FR RL RR TREATED AREA

FL FR RL RR TREATED AREA

FL FR RL RR TREATED AREA

FL FR RL RR TREATED AREA

FL FR RL RR TREATED AREA

FL FR RL RR TREATED AREA

FL FR RL RR TREATED AREA

FL FR RL RR TREATED AREA

FL FR RL RR TREATED AREA

FL FR RL RR TREATED AREA

FL FR RL RR TREATED AREA

FL FR RL RR TREATED AREA

FL FR RL RR TREATED AREA

FL FR RL RR TREATED AREA

FL FR RL RR TREATED AREA

FL FR RL RR TREATED AREA

FRONT

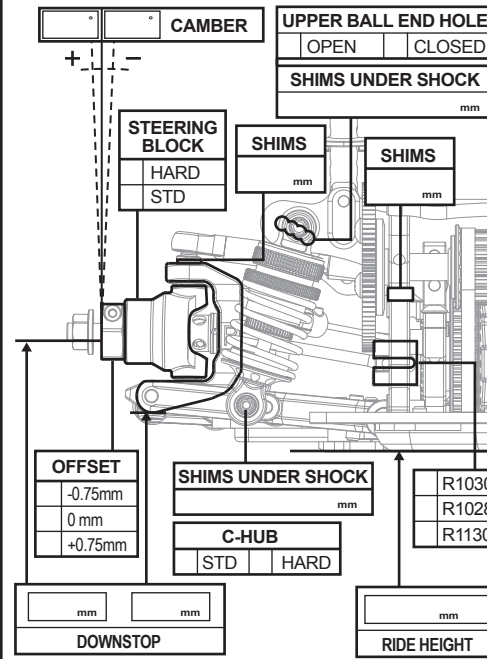

REAR

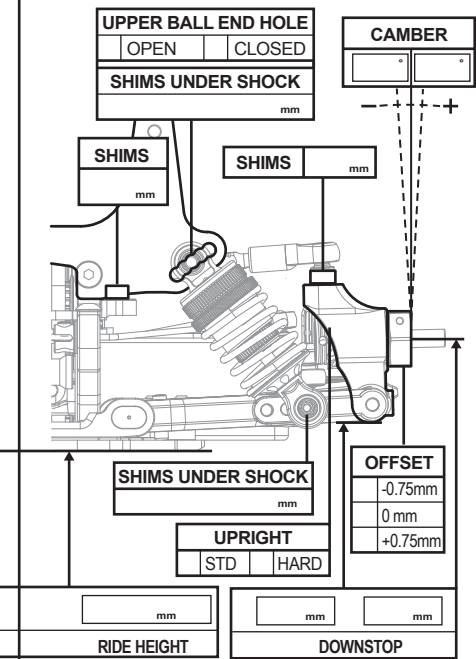

Front Shock Position

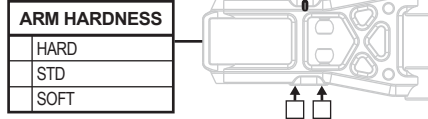

Rear Shock Position

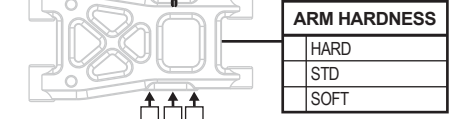

SUSPENSION INSERT CHART

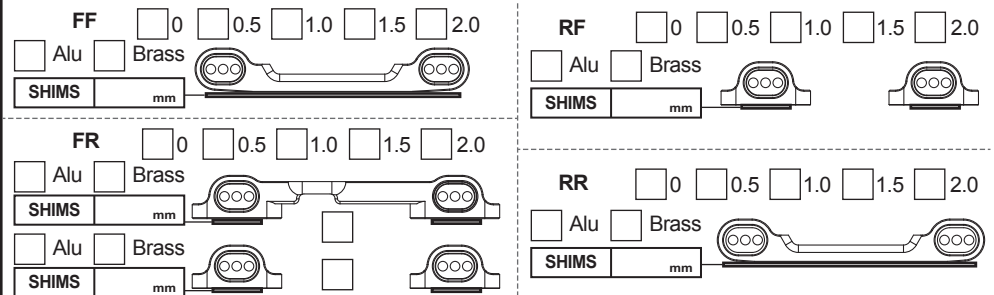

BATTERY ALEGMENT

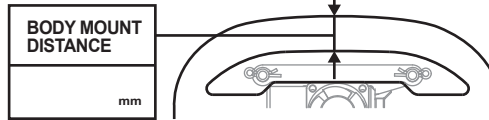
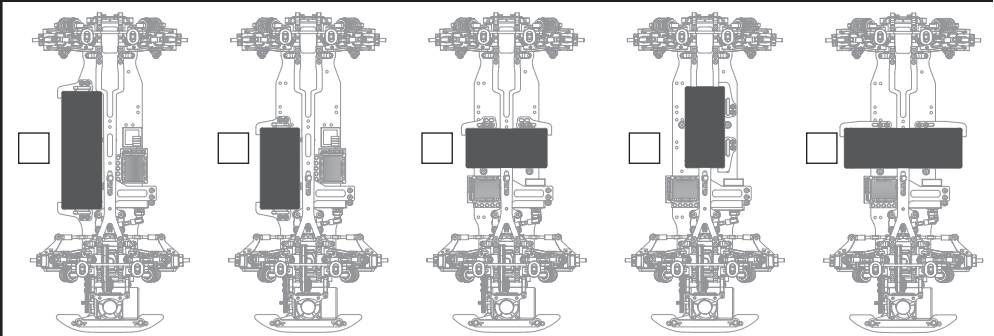

BODY **WING**

STEER BLOCK SHIMS

STEER BLOCK SETUP R118041

BUMP STEER SHIMS mm

NOTE

NOTE

NOTE

NOTE

NOTE

NOTE

NOTE

NOTE

NOTE

NOTE

NOTE

NOTE

